



KATALOG TECHNICZNY
01.09.2013 DZIEWIĄTA EDYCJA

Charakterystyka mebli:

- meble biurowe wykonane z płyty meblowej obustronnie melaminowanej o grubości 18mm; blaty biurek o grubości 25mm
 - wszystkie krawędzie oklejone są obrzeżem PVC/ABS w kolorze płyty. Grubość obrzeża min. 0,6-0,8mm lub 2mm, w przypadku blatów i wieńców szaf- 2mm
 - w kontenerach zostały zastosowane metalowe prowadnice samodomykające oraz zamki centralne (opcja)
 - w szafach zastosowano zamki patentowe z dwoma kluczami oraz uchwyty o rozstawie 96-128mm.
- Wszystkie szafy są posadowione na stopkach z regulacją. W drzwiach szaf zastosowano zawiasy samodomykające z możliwością regulacji w trzech płaszczyznach. Odległości półek dostosowane są do wysokości segregatorów.
- podstawowa kolorystyka mebli to: Mahoń Togo, Buk bawaria, Olcha, Wiśnia Oxford, Dzika grusza, Klon thansau, Szary, Orzech [3 dekory], Dąb Sedan, Brzoza Alaska, Szary grafit, Biały, Czarny.
- Niniejszy folder stanowi fragment kompleksowej oferty mebli biurowych zawartej w katalogu „Meble biurowe. Katalog techniczny”. Katalog ten chętnie udostępnią Państwu nasi przedstawiciele, udzielą oni również wszelkich niezbędnych informacji.

Systemy biurek:

B- biurka na stelażu płytowym.



BM- biurka na stelażu metalowym. Wnętrze nogi wypełnione płytą meblową lub blachą [gładką lub perforowaną- dopłata 45pln]. Nogi wyposażone w regulatory poziomowania.

BMB- wersja biurka BM z dodatkową blendą osłonową mocowaną pomiędzy nogami [dopłata 45pln]



BN- biurka na stelażu metalowym; rama podblatowa z czterema nogami wykonana z profilu 40x40mm lub fi 50mm. Nogi wyposażone w regulatory poziomowania. Możliwe wykonanie stelaża z innych profili.

BMK- biurka na stelażu metalowym. Belka prowadzona pod spodem wzdłuż blatu oraz stopa ze zdejmowaną osłoną umożliwiają uporządkowanie i odprowadzenie kabli od urządzeń znajdujących się na biurku. Na blacie znajdują się dwa przepusty kablowe; nogi wyposażone są w regulatory poziomowania.













BMK lux- biurko typu BMK z inną wizualnie wersją stelaża- wycena indywidualna



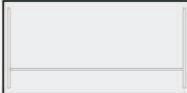

Standardowa kolorystyka stelaży metalowych: czarny lub aluminium [RAL 9006]

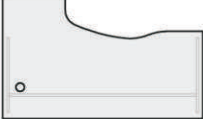
BIURKA



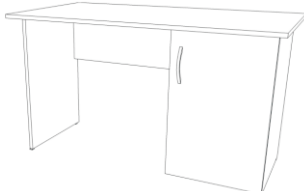

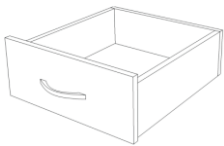









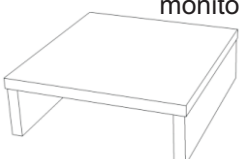



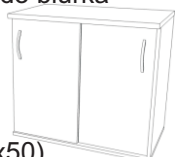

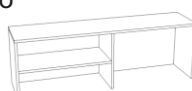
Rodzaj biurka wymiar					
 120x70x74H 245zł	B1 245zł	BM1 295zł	BMK1 395zł	BN1 338zł	R1 539zł
 140x70x74H 269zł	B2 269zł	BM2 315zł	BMK2 419zł	BN2 389zł	R2 563zł
 160x70x74 295zł	B3 295zł	BM3 355zł	BMK3 469zł	BN3 433zł	R3 599zł
 140/50x100/70x74H 355zł	B4 355zł	BM4 395zł	BMK4 499zł	BN4 475zł	R4 638zł
 140/50x100/70x74H 355zł	B5 355zł	BM5 395zł	BMK5 499zł	BN5 475zł	R5 638zł
 160/50x100/70x74H 369zł	B6 369zł	BM6 435zł	BMK6 549zł	BN6 531zł	R6 682zł
 160/50x100/70x74H 369zł	B7 369zł	BM7 435zł	BMK7 549zł	BN7 531zł	R7 682zł

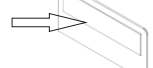
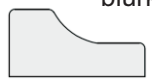



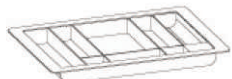















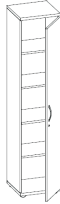

BIURKA c.d.

<p>B8 Biurko pełne z szufladami</p>  <p>A: 140x70x74H 449zł B: 120x70x74H 425zł</p>	<p>B9 Biurko pełne</p>  <p>A: 140x70x74H 395zł B: 120x70x74H 369zł</p>	<p>B10 Biurko pełne z szufladą</p>  <p>A: 140x70x74H 430zł B: 120x70x74H 405zł</p>	<p>B11 Dodatkowa szuflada</p>  <p>49zł</p>
---	--	---	---



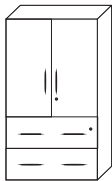
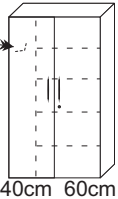



* Dopłata za zamek centralny-30zł

ELEMENTY DOPOSAŻENIA BIUREK

<p>D1 Dostawka</p>  <p>70x70x2,5H 88zł</p> <p>+noga Ø60 lakier 49zł chrom 49zł</p>	<p>D2 Dostawka</p>  <p>Ø100x2,5H 129zł</p> <p>+noga Ø60 lakier 49zł chrom 49zł</p>	<p>D3 Dostawka</p>  <p>140x50x2,5H 144zł</p> <p>+noga Ø60 lakier 49zł chrom 49zł</p>	<p>D4 Dostawka</p>  <p>Ø100x2,5H 144zł</p> <p>+noga Ø60 lakier 49zł chrom 49zł</p>	<p>D5 Nadstawka pod monitor</p>  <p>30x30x10H 47zł</p>
<p>D6 Kontener bez zamka*</p>  <p>43x45x56H 288zł</p>	<p>D7 Kontener+blat bez zamka*</p>  <p>43x50x74H 375zł</p>	<p>D8 Kontener z szufladami Metabox bez zamka*</p>  <p>43x45x56H 345zł</p>	<p>D9 Kontener z szufladami Metabox i piórnikiem bez zamka*</p>  <p>43x45x62H 379zł</p>	<p>D10 Szafka suwana do biurka</p>  <p>(blat 80x50) 80x45x74H 335zł</p>
<p>D11 Szafka do biurka</p>  <p>(blat 80x50) 80x45x74H 259zł</p>	<p>D12 Nadstawka na biurko</p>  <p>A: 80x35x45H 139zł B: 120x35x45H 169zł C: 140x35x45H 189zł D: 160x35x45H 209zł</p>	<p>D13 Przegroda do biurka</p>  <p>70x60x1,8 99zł</p>	<p>D14 Przegroda do biurka</p>  <p>A: 120x60x1,8H 143zł B: 140x60x1,8H 165zł C: 160x60x1,8H 188zł D: 180x60x1,8H 218zł</p>	<p>D15 Tapicerka do ścianek D14</p>  <p>A: 100x25H 110zł B: 125x25H 130zł C: 145x25H 150zł D: 165x25H 180zł</p>
<p>D16 Przegroda do biurka</p>  <p>A: 120x60x1,8H 143zł B: 140x60x1,8H 168zł C: 160x60x1,8H 195zł D: 180x60x1,8H 218zł</p>	<p>D17 Szuflada klawiatury plastikowa</p>  <p>55x27x1,8H 69zł</p>	<p>D18 Szuflada klawiatury</p>  <p>70x35x1,8H 59zł</p>	<p>D19 Blenda metalowa</p>  <p>ST314 do biurka dł.120cm 194zł ST315 do biurka dł.140cm 199zł St316 do biurka dł.160cm 210zł</p>	<p>D20 Blenda z płyty</p>  <p>B910 do biurka dł.120cm 139zł B911 do biurka dł.140cm 149zł B912 do biurka dł.160cm 155zł</p>
<p>D21 Piórnik do szuflady</p>  <p>24x34x30H 35zł</p>	<p>D22 Wózek pod komputer</p>  <p>29x47x23H 52zł</p>	<p>D23 Przepust kablowy</p>  <p>średnica 60mm 8zł</p>	<p>D24 Pionowe prowadzenie kabli</p>  <p>95zł</p>	<p>D25 Poziome prowadzenie kabli</p>  <p>100cm 59zł</p>

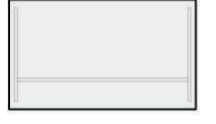

<p>S1 Szafa aktowa</p>  <p>80x38x184H 429zł</p>	<p>S2 Szafa ubraniowa</p>  <p>80x38x184H 429zł</p>	<p>S3 Szafo-regał aktowy</p>  <p>80x38x184H 359zł</p>	<p>S4 Szafo-regał aktowy</p>  <p>80x38x184H 349zł</p>
<p>S5 Regał aktowy</p>  <p>80x38x184H 269zł</p>	<p>S6 Szafa aktowa</p>  <p>80x38x184H 441zł</p>	<p>S7 Szafa aktowa</p>  <p>80x38x184H 450zł</p>	<p>S8 Szafa aktowa</p>  <p>80x38x113H 273zł</p>
<p>S9 Szafo-regał aktowy</p>  <p>80x38x113H 252zł</p>	<p>S10 Regał aktowy</p>  <p>80x38x113H 171zł</p>	<p>S11 Szafa aktowa</p>  <p>80x38x78H 252zł</p>	<p>S12 Regał aktowy</p>  <p>80x38x78H 171zł</p>
<p>S13 Nadstawka</p>  <p>80x38x78H 234zł</p>	<p>S14 Nadstawka</p>  <p>80x38x78H 153zł</p>	<p>S15 Szafo-regał aktowy</p>  <p>40x38x184H 333zł</p>	<p>S16 Szafa ubraniowa</p>  <p>40x60x184H 360zł</p>
<p>S17 Szafa ubraniowa</p>  <p>55x38x184H 339zł</p>	<p>S18 Szafa ubraniowo-aktowa</p>  <p>80x38x184H 469zł</p>	<p>S19 Szafa na teczki zawieszkowe</p>  <p>80x42x184H 895zł</p>	<p>S20 Szafa BHP z półkami</p>  <p>hak na wąż odkurzacza</p> <p>40cm 60cm</p> <p>100x38x184H 479zł</p>
<p>S21 Regał aktowy</p>  <p>38x38x184H 259zł</p>	<p>S22 Regał aktowy średni</p>  <p>38x38x113H 185zł</p>	<p>S23 Drzwi szklane do S4</p>  <p>szkło bezbarwne 179zł szkło w ramce aluminiowej 383zł</p>	<p>Więcej mebli w katalogu: Meble biurowe "Office" Katalog techniczny</p>

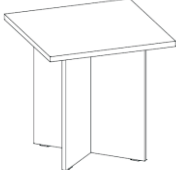
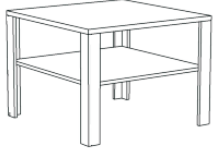
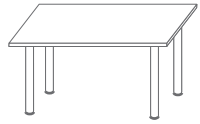
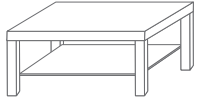
**STOŁY KONFERENCYJNE, STOLIKI
OKOLICZNOŚCIOWE**

<p>Rodzaj stołu</p> <p>wymiar</p>		 <p>noga 40x40 lub fi 50</p>	
 <p>100x60x74H</p>	<p>SK1</p> <p>239zł</p>	<p>SKN1</p> <p>318zł</p>	<p>SKM1</p> <p>279zł</p>
 <p>180x70x74H</p>	<p>SK2</p> <p>279zł</p>	<p>SKN2</p> <p>463zł</p>	<p>SKM2</p> <p>385zł</p>
 <p>225x100x74H</p>	<p>SK3</p> <p>369zł</p>	<p>SKN3</p> <p>560zł</p>	<p>SKM3</p> <p>445zł</p>
 <p>225x95x74H</p>	<p>SK4</p> <p>414zł</p>	<p>SKN4</p> <p>590zł</p>	<p>SKM4</p> <p>475zł</p>
<p>SK5 Stolik</p>  <p>A:60x60x60H 179zł B:70x70x60H 189zł C:80x80x60H 199zł D:100x60x60H 220zł</p>	<p>SK6 Stolik</p>  <p>A:60x60x60H 189zł B:70x70x60H 199zł C:80x80x60H 209zł D:100x60x60H 230zł</p>	<p>SK7 Stolik</p>  <p>100x60x73H 226zł</p>	<p>SK8 Stolik na drewnianych nogach</p>  <p>90x55x45H 299zł</p>

STOŁY KONFERENCYJNE, STOLIKI OKOLICZNOŚCIOWE c.d.

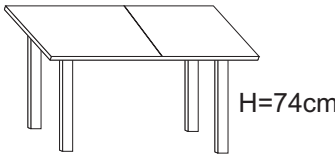
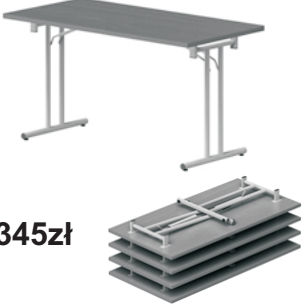

ceny netto

<p>Sk9 Stół rozsuwany na stelażu drewnianym</p>  <p>H=74cm</p> <p>A:140-200x80 839zł B:140-200x70 825zł</p>	<p>Sk10 Stół na stelażu składanym, 150x70cm</p>  <p>345zł</p>	<p>Sk11 Stół mobilny na stelażu składanym 150x70cm</p>  <p>655zł</p>	<p>Sk12 Stół mobilny na stelażu składanym 150x70cm</p>  <p>689zł</p>
---	---	---	--

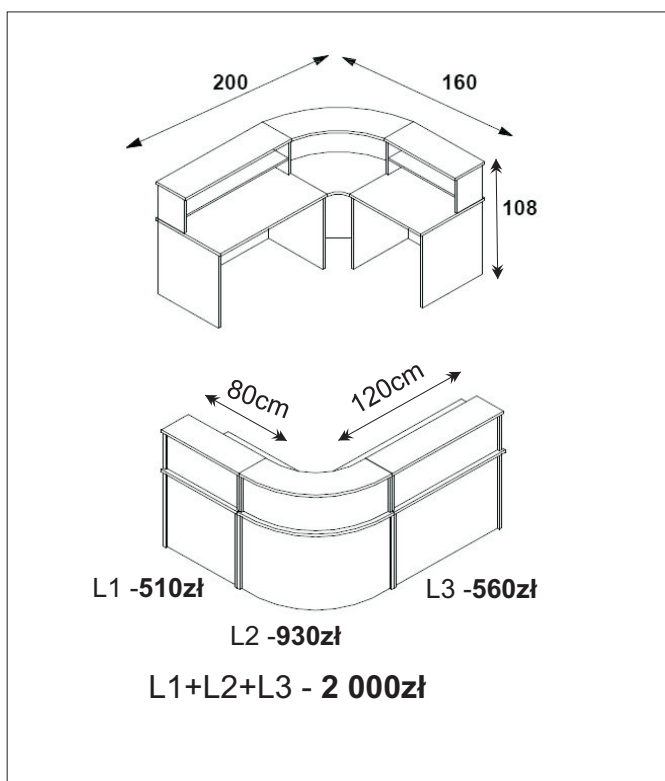
LADA RECEPCYJNA













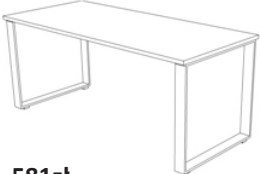

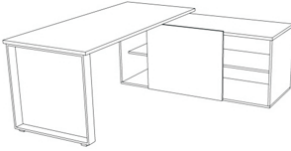
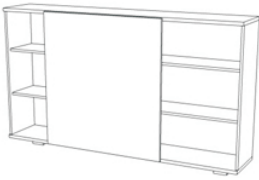
ELEMENTY UZUPEŁNIAJĄCE

<p>U1 Wieszak</p>  <p>60x30x130H 193zł 90x30x130H 259zł</p>	<p>U2 Panel odbojowy</p>  <p>25x50cm 49zł</p>
--	---

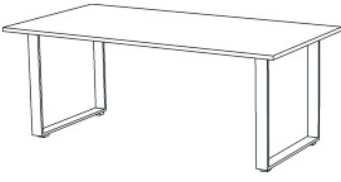
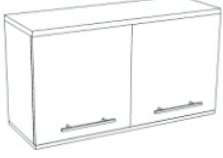
CHARAKTERYSTYKA SYSTEMU ROLLINS

- konstrukcja szaf - wieńcowa; wieńiec górny, dolny i półki z płyty #25mm
- drzwi z cichym domykiem
- zamki 3-punktowe [baskwilowe]
- cokół 6cm, stopki z regulacją poziomowania
- szuflady typu metabox, z cichym domykiem
- układ stojów w drzwiach pionowy lub poziomy
- w blatach biurka po 2 przelotki kablowe
- w biurkach pod blatami - rama wzmacniająca
- nogi w profila metalowego o przekroju 60x30mm, malowane proszkowo
- na blatach laminat wysokociśnieniowy HPL [opcja]

LINIA MEBLI BIUROWYCH ROLLINS







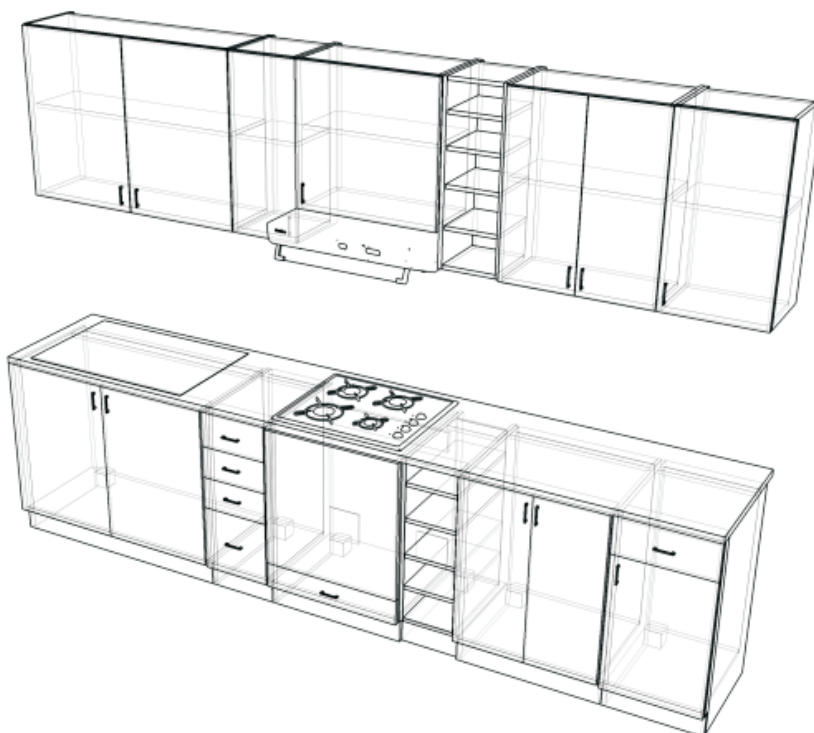



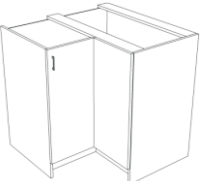

<p>R01 Biurko pojedyncze</p>  <p>120x80cm 581zł 140x80cm 614zł 160x80cm 653zł 180x80cm 689zł</p>	<p>R02 Biurko z pomocnikiem, szuflady</p>  <p>160x80cm 1 566zł 180x80cm 1 588zł</p> <p>pomocnik 160x40cm, do wysokości blatu</p>	<p>R03 Biurko z pomocnikiem, półki</p>  <p>160x80cm 1 389zł 180x80cm 1 410zł</p> <p>pomocnik 160x40cm, do wysokości blatu</p>
<p>R04 Szafa z drzwiami przesuwными</p>  <p>200x40x113cm 1 190zł</p>	<p>R05 Szafka z drzwiami przesuwными i 4 szufladami</p>  <p>200x45x113cm 1 590zł</p>	<p>R06 Szafka z drzwiami przesuwными i 4 szufladami</p>  <p>300x45x113cm 2 090zł</p>
<p>R07 Szafa aktowo-ubraniowa</p>  <p>100x42x190cm 840zł</p>	<p>R08 Kontener podblatowy, mobilny, z piórnikiem</p>  <p>43x45x62cm 530zł</p>	<p>R09 Stół konferencyjny</p>  <p>200x100x74cm 890zł</p>
<p>R10 Szafka wisząca</p>  <p>100x30x55cm 770zł</p>	<p>R11 Szafka stojąca</p>  <p>100x45x113cm 460zł</p>	<p>R12 Przegroda międzybiurkowa tapicerowana jednostronnie</p>  <p>szerokości: 80cm - 180zł, 120cm - 224zł, 140cm - 266zł, 160cm - 321zł, 180cm - 366zł</p>
<p>R12 Przegroda międzybiurkowa tapicerowana, z listwą organizacyjną; jednostronna</p>  <p>szerokości: 80cm - 229zł, 120cm - 280zł, 140cm - 338zł, 160cm - 399zł, 180cm - 439zł</p>	<p>R13 Wyposażenie do listwy organizacyjnej lampka 69zł</p>  <p>półka na dokumenty 88zł</p> 	<p>R14 Szafa aktowa z zamkiem baskwilowym, półki 25mm</p>  <p>100x42x190cm 790zł</p>

MEBLE KUCHENNE, aneksy socjalne korpusy i fronty z płyty melaminowanej



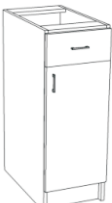
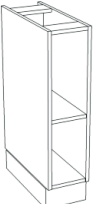



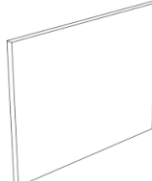







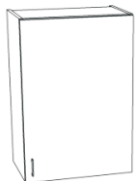

ceny netto



SZAFKI DOLNE

<p>K1 Szafka</p>  <p>80x52x82H 279zł</p>	<p>K2 Szafka zlewozmywakowa</p>  <p>80x52x82H 279zł</p>	<p>K3 Szafka do zabudowy piekarnika</p>  <p>60x52x82H 258zł</p>	<p>K4 Szafka narożna</p>  <p>90x90x82H 479zł</p>	<p>K5 Szafka</p>  <p>60x52x82H 243zł</p>
<p>K6 Szafka z szufladą</p>  <p>50x52x82H 257zł</p>	<p>K7 Szafka</p>  <p>40x52x82H 218zł</p>	<p>K8 Szafka z szufladami</p>  <p>40x52x82H 412zł</p>	<p>K9 Szafka</p>  <p>30x52x82H 199zł</p>	<p>K10 Szafka z szufladą</p>  <p>30x52x82H 238zł</p>
<p>K11 Szafka otwarta</p>  <p>20x50x82H 179zł</p>	<p>K12 Szafka z szufladami</p>  <p>20x52x82H 238zł</p>	<p>K13 Szafka lewa narożna</p>  <p>30x50x82H 199zł</p>	<p>K14 Szafka prawa narożna</p>  <p>30x50x82H 199zł</p>	<p>K15 Błat</p>  <p>plyta #25 98zł/mb postforming #28 120zł/mb listwa przyścienna 18zł/mb</p>

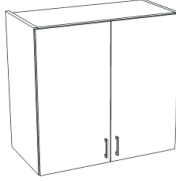
SZAFKI GÓRNE

<p>K16 Witryna</p>  <p>80x32x72H 416zł</p>	<p>K17 Szafka</p>  <p>80x32x72H 257zł</p>	<p>K18 Szafka z ociekaczem</p>  <p>80x32x72H 297zł</p>	<p>K19 Szafka narożna</p>  <p>60x60x72H 297zł</p>	<p>K20 Szafka</p>  <p>60x32x72H 238zł</p>
<p>K21 Szafka</p>  <p>50x32x72H 218zł</p>	<p>K22 Szafka</p>  <p>40x32x72H 193zł</p>	<p>K23 Szafka</p>  <p>30x32x72H 150zł</p>	<p>K24 Szafka otwarta</p>  <p>20x30x72H 150zł</p>	<p>K25 Szafka z szufladami</p>  <p>20x32x72H 199zł</p>
<p>K26 Szafka nadokapowa</p>  <p>60x32x40H 277zł</p>	<p>K27 Szafka nadokapowa</p>  <p>50x32x40H 258zł</p>	<p>K28 Szafka narożna</p>  <p>30x30x72H 189zł</p>	<p>K29 Witryna</p>  <p>80x32x60H 396zł</p>	<p>K30 Szafka</p>  <p>80x32x60H 238zł</p>
<p>K31 Szafka</p>  <p>60x32x60H 218zł</p>	<p>K32 Szafka</p>  <p>40x32x60H 178zł</p>			

Koszty montażu:

- montaż mebli kuchennych - od 7% do 20% wartości mebli, do indywidualnej wyceny [w tej cenie zawarty jest montaż szafek dolnych i wiszących oraz blatu]
- powieszenie szafki - 38pln/sztuka
- montaż okapu - 50pln
- podłączenie okapu do wentylacji - 50pln + koszt materiałów
- osadzenie w blacie zlewu, płyty grzewczej - 50pln/sztuka
- montaż sprzętu AGD do zabudowy - 100pln/sztuka
- listwa przyblatowa - 18pln/mb [z montażem]
- szafka dolna na nóżkach z dopinany cokołem - dopłata 40pln
- fronty lakierowane, HPL, inne - wg indywidualnej wyceny

PRZYKŁADOWE ARANŻACJE

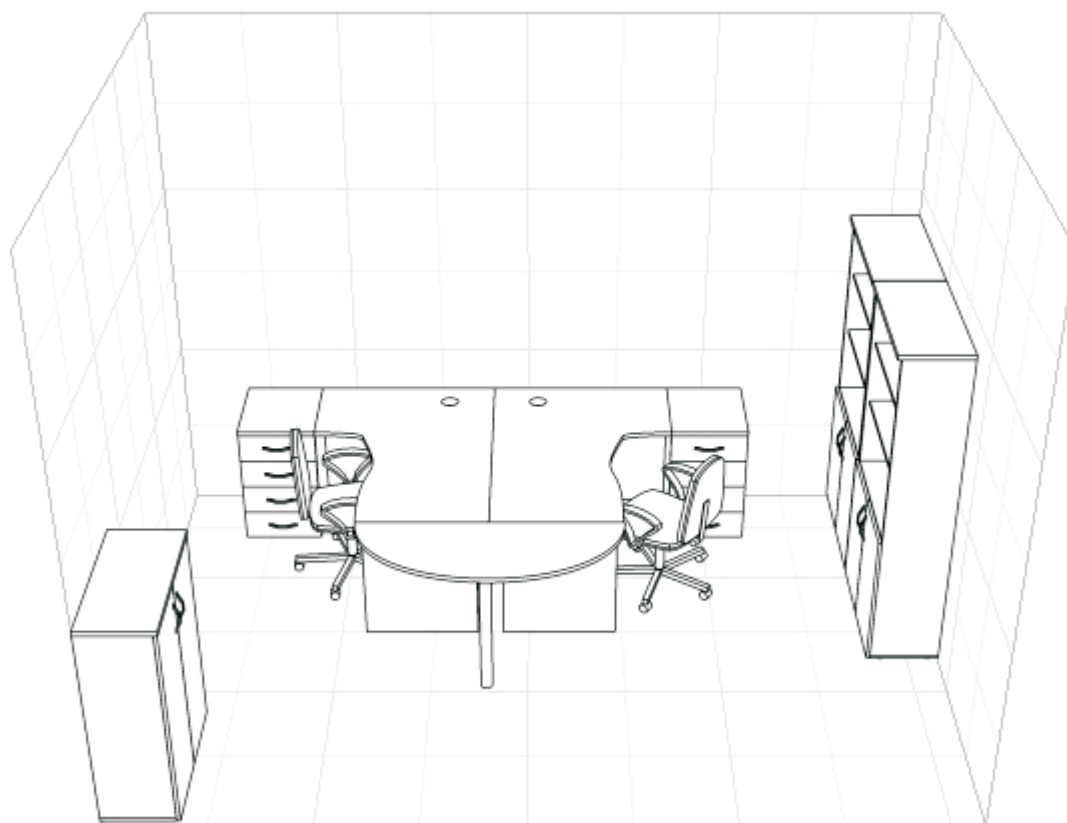
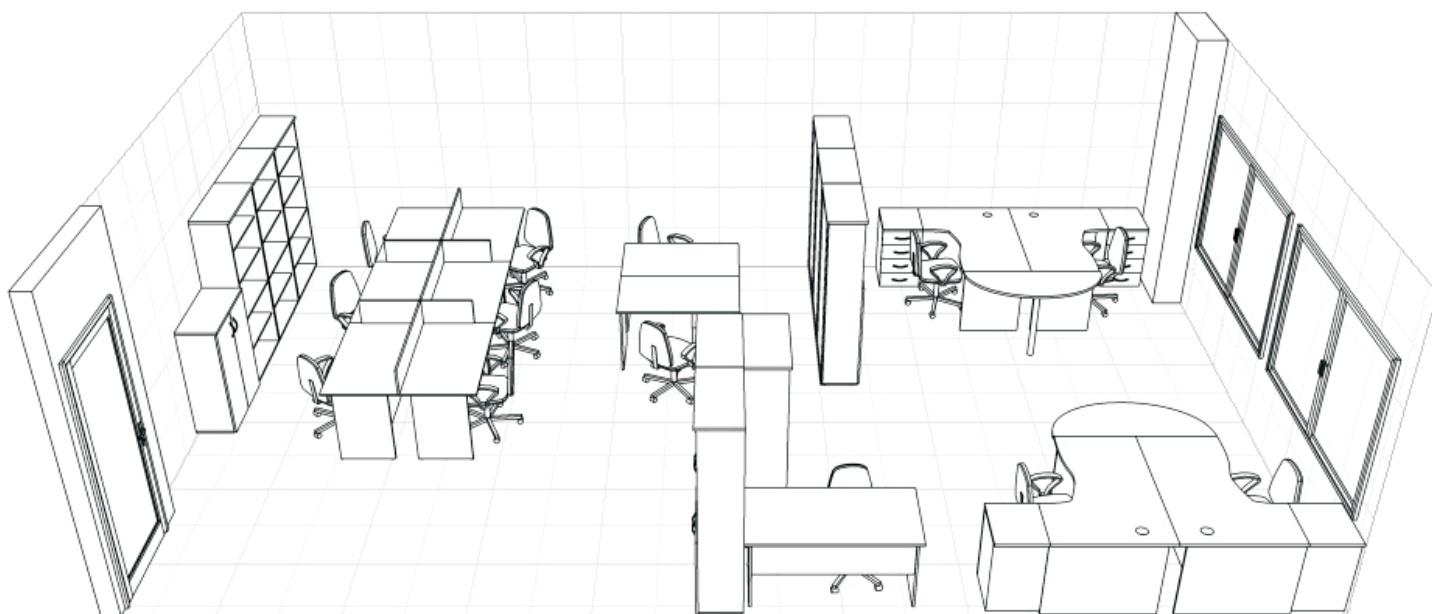

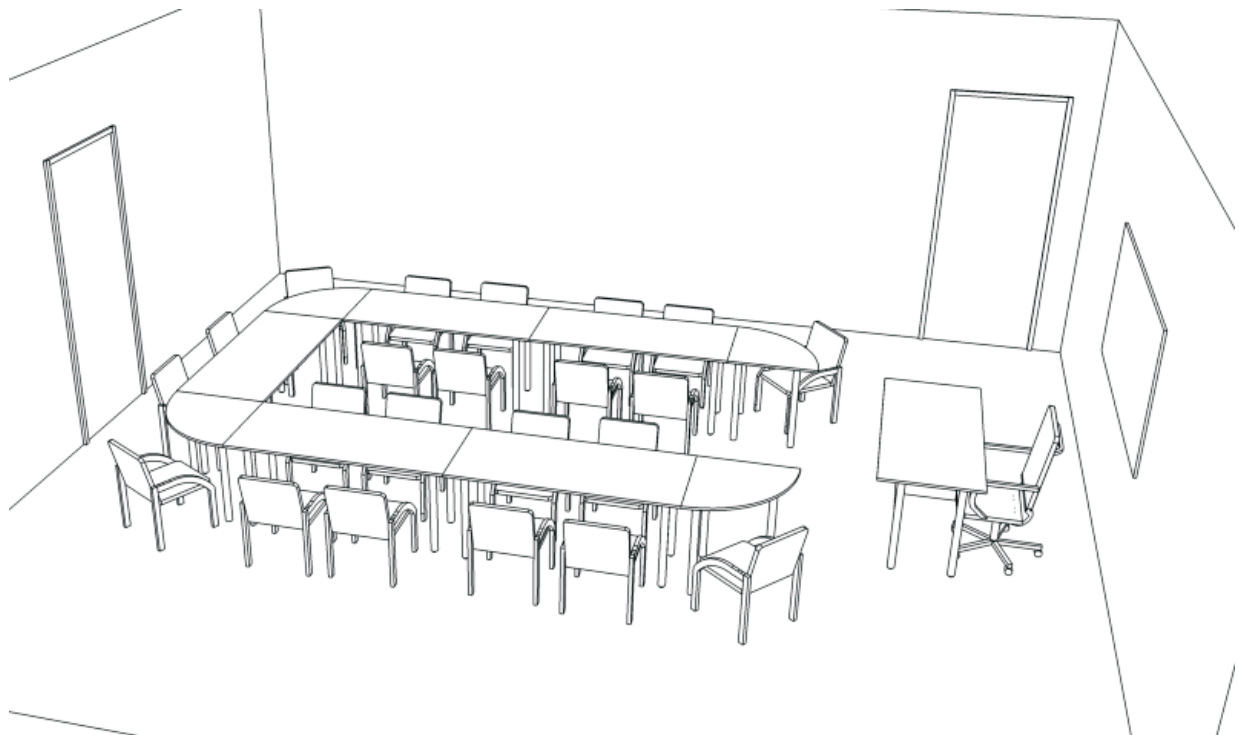
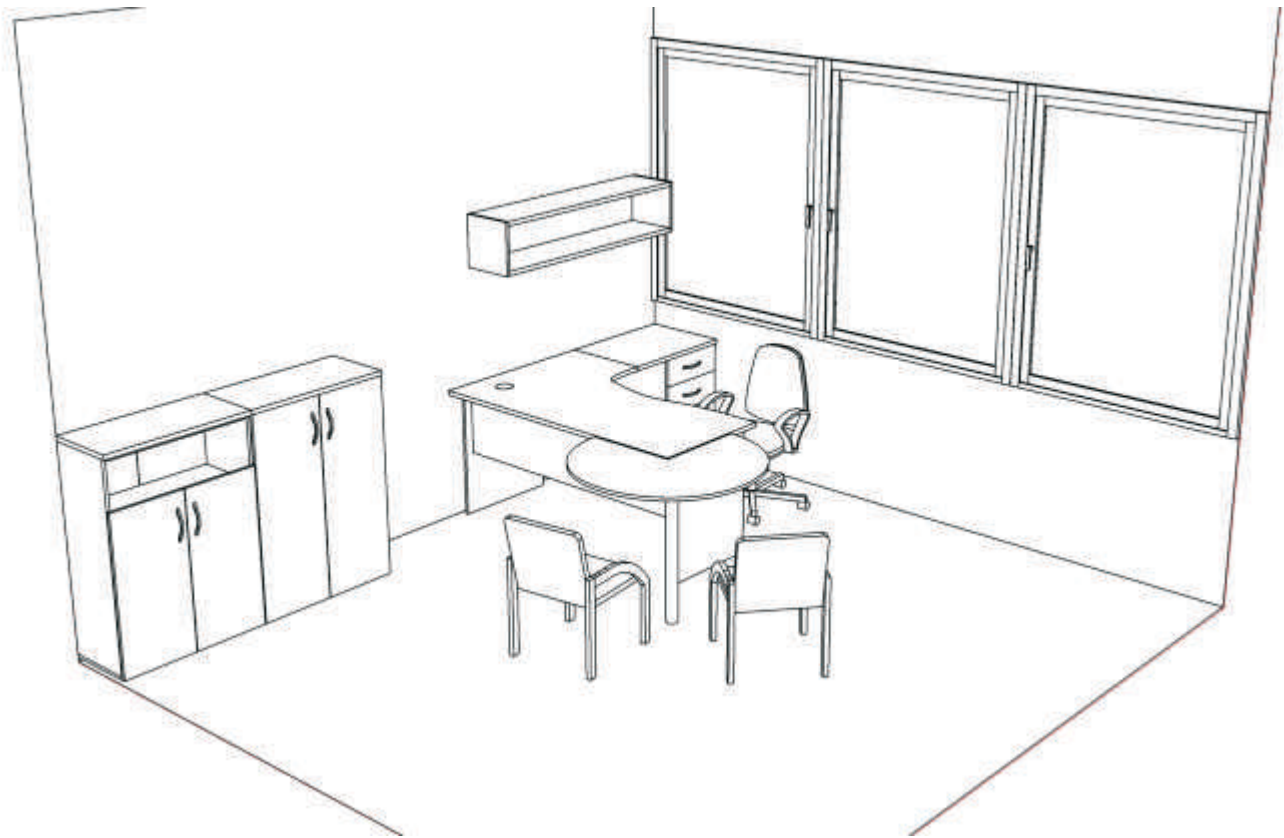

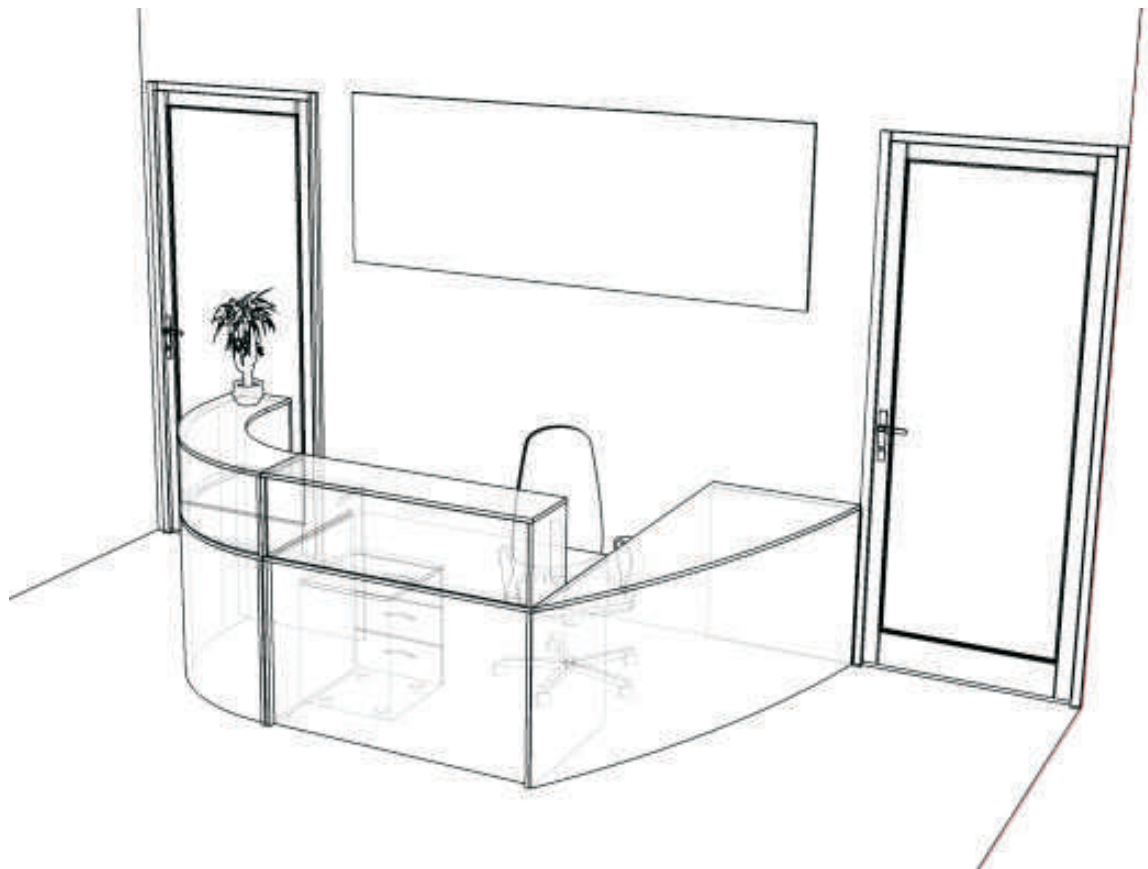

PODSTAWOWA KOLORYSTYKA

I grupa

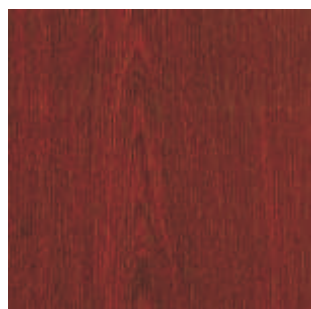

Mahoń togo



Buk bawaria



Olcha

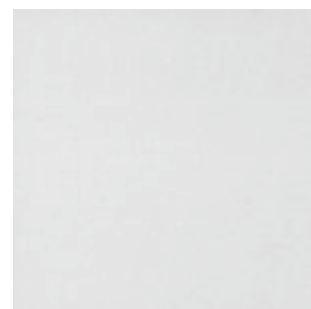

Szary



Wiśnia Oxford



Dzika grusza



Klon Thansau

II grupa

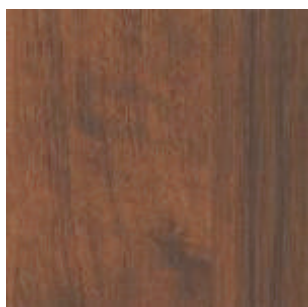

Orzech 53

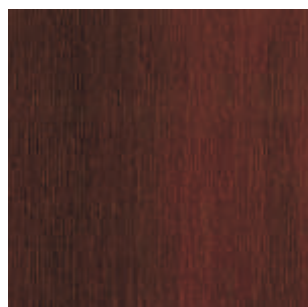

Orzech 35



Orzech 42



Dąb Sedan



Brzoza alaska



Szary grafit

uzupełnienie

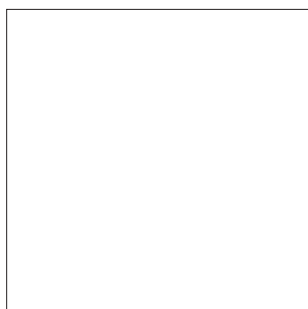

Biały

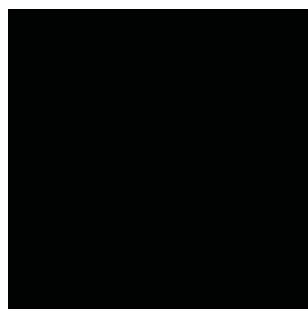

Czarny



Aluminium

UCHWYTY

standard



C-623

Uchwyt przewężany zn Lo=96 mm
Rozstaw: 96
Szerokość: 10
Wysokość: 25
Długość całkowita: 115



C-624

Uchwyt przewężany zn Lo=128 mm
Rozstaw: 128
Szerokość: 11
Wysokość: 28
Długość całkowita: 160

za dopłatą



C-903

Uchwyt zn Lo=96 mm
Rozstaw: 96
Szerokość: 18
Wysokość: 28
Długość całkowita: 128



C-1043

Uchwyt Rigel zn Lo=96 mm
Rozstaw: 96
Szerokość: 14
Wysokość: 23
Długość całkowita: 120



C-763

Uchwyt techno zn Lo=96 mm
Rozstaw: 96
Szerokość: 8
Wysokość: 28
Długość całkowita: 130



C-334

Uchwyt zn Lo=128 mm
Rozstaw: 128
Średnica: 10
Wysokość: 28
Długość całkowita: 157

**Dostępne są również inne wzory, kolory i rozstawy uchwytów -
według indywidualnych uzgodnień**

Ogólne zasady sprzedaży:

-usługa transportowa i montaż są zawarte w cenie mebli przy wielkości zamówienia przekraczającej 3500pln netto. Poniżej tej kwoty obowiązuje opłata logistyczna 250pln netto.

-przy jednorazowym zamówieniu powyżej 10 000pln netto lub przy zamówieniu elementów powtarzalnych udzielamy rabat od cen katalogowych - proszę zapytać o aktualną promocję

-wniesienie mebli [usługa tragarzka] w niektórych przypadkach wymaga dopłaty [brak windy, duże odległości]

-istnieje możliwość wykonania aranżacji meblowanych pomieszczeń [rozplanowania mebli]

-termin realizacji zamówienia wynosi 14-21 dni

-gwarancja na meble objęte promocją wynosi 24 miesiące

MEBLE ZOSTAŁY WYKONANE WEDŁUG PONIŻSZYCH NORM I WYTYCZNYCH:

- PN-EN-527-1/2/3: 2004. Meble biurowe- stoły robocze i biurka; 1- wymiary, 2- mechaniczne wymagania bezpieczeństwa, 3- metody oznaczania stateczności i mechanicznej wytrzymałości konstrukcji

- PN-EN 14073-2/3: 2006. Meble biurowe- meble do przechowywania; 2- wymagania bezpieczeństwa, 3- metody oznaczania stateczności i mechanicznej wytrzymałości konstrukcji

- akcesoria, kleje i okleina PVC/ABS użyte do produkcji mebli posiadają atesty higieny

- płyta melaminowana w klasie higieny E1

